

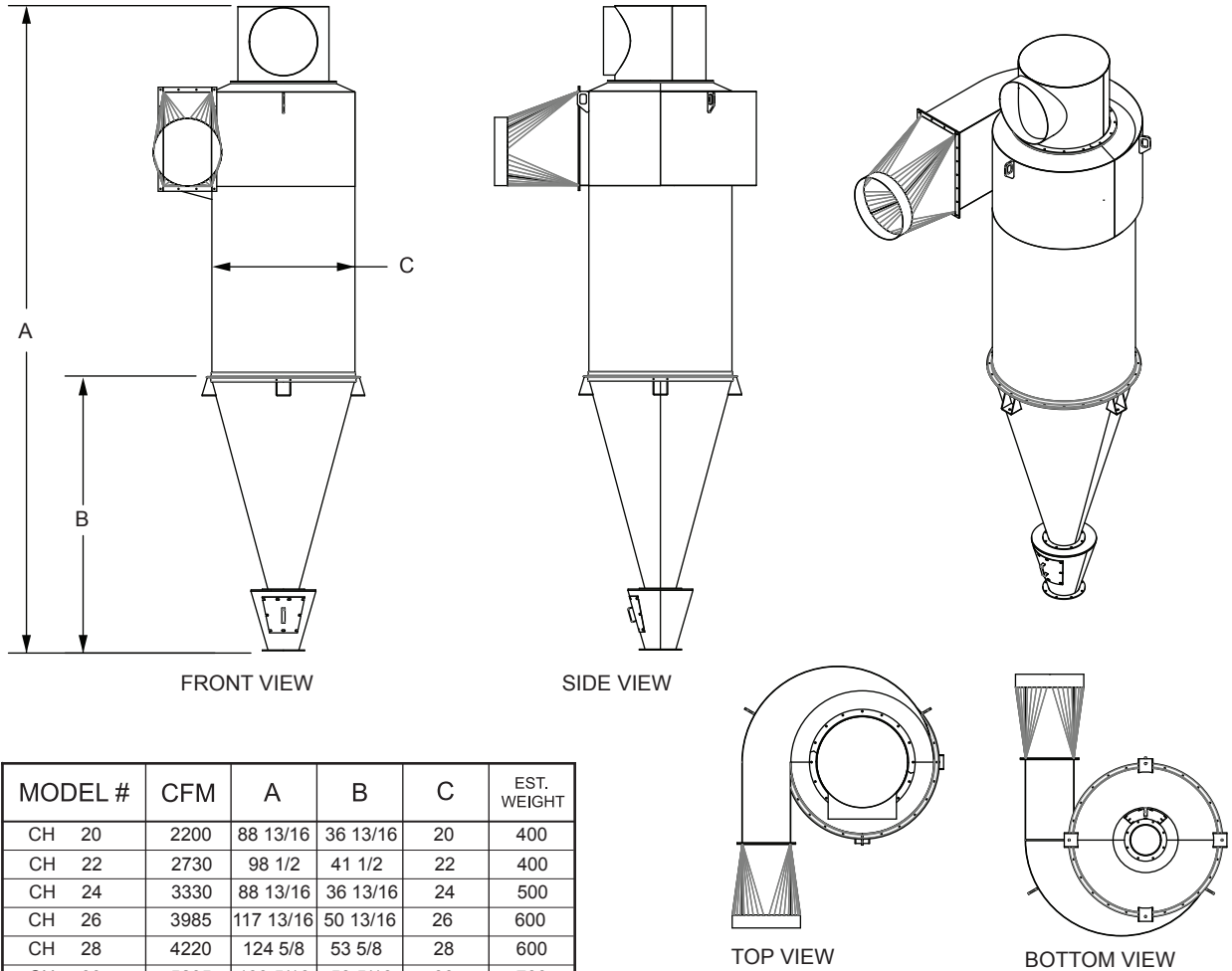

CH CYCLONE COLLECTORS

KICE INDUSTRIES, INC. / 5500 Mill Heights Drive / Park City, KS 67219 www.kice.com / sales@kice.com



MODEL #	CFM	A	B	C	EST. WEIGHT
CH 20	2200	88 13/16	36 13/16	20	400
CH 22	2730	98 1/2	41 1/2	22	400
CH 24	3330	88 13/16	36 13/16	24	500
CH 26	3985	117 13/16	50 13/16	26	600
CH 28	4220	124 5/8	53 5/8	28	600
CH 30	5205	133 5/16	58 5/16	30	700
CH 32	6015	142 15/16	62 15/16	32	800
CH 34	6300	150 5/8	67 5/8	34	900
CH 36	7185	161 5/16	72 5/16	36	900
CH 38	8460	169 15/16	76 15/16	38	1000
CH 40	8800	179 1/8	81 5/8	40	1100
CH 42	9840	190 3/16	88 3/16	42	1200

NOTES:

- DIMENSIONS SHOWN MAY VARY DEPENDING ON JOB REQUIREMENTS
- OPTIONAL SUPPORT FEET SHOWN
- OPTIONAL INSPECTION DOOR
- FOOTPRINT DIMENSIONS UPON REQUEST
- OTHER SIZES AVAILABLE UPON REQUEST